

Escola: _____

Nome: _____

Professor: _____

COMPLETE AS SEQUÊNCIAS

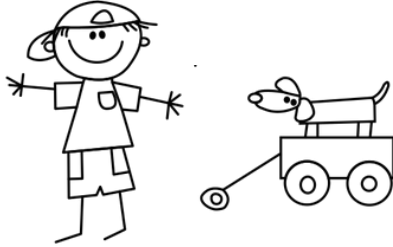

0		2		4
	6		8	

10



	1		3	
5		7		9

--

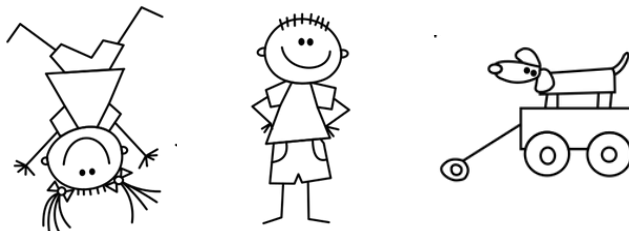

0	1			4
5				9

10

 CURSOS <https://superpreparadocursos.com.br/>

Escola: _____

Nome: _____

Professor: _____

LIGA LIGA

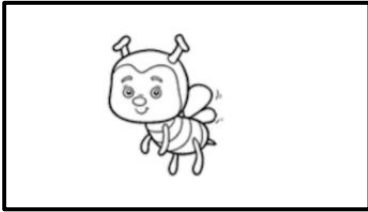
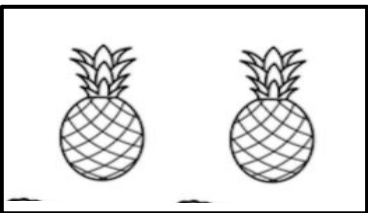
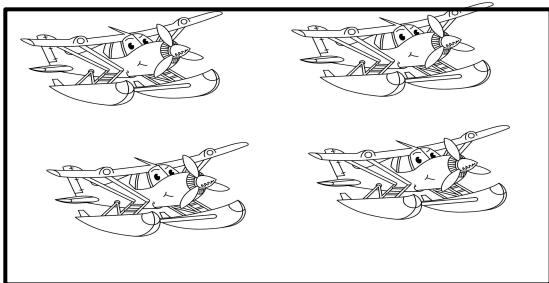
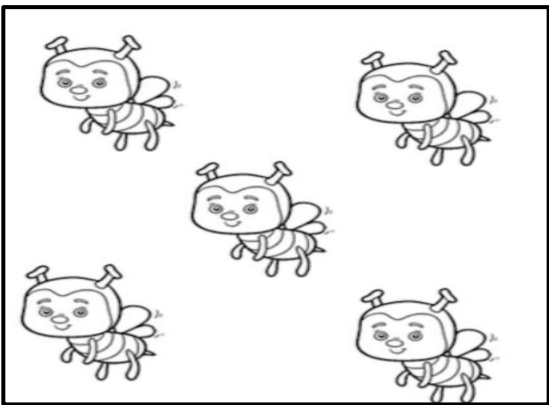
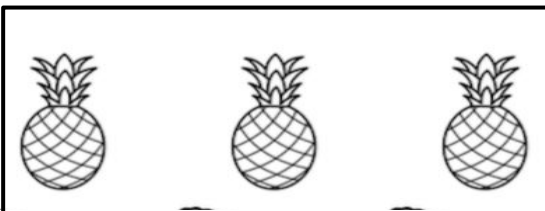



**1****2****3****4****5**

Escola: _____

Nome: _____

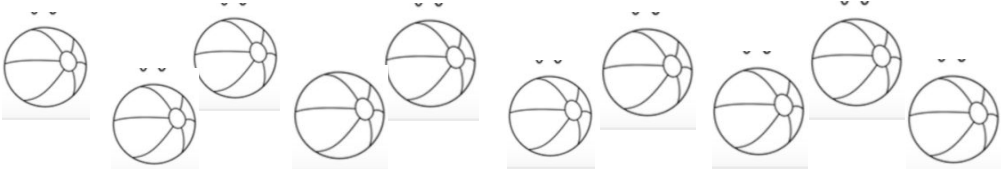
Professor: _____

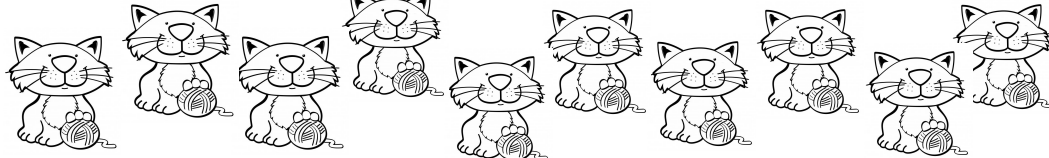
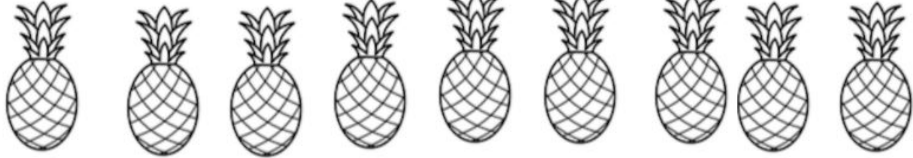
PINTE DE ACORDO COM OS NÚMEROS

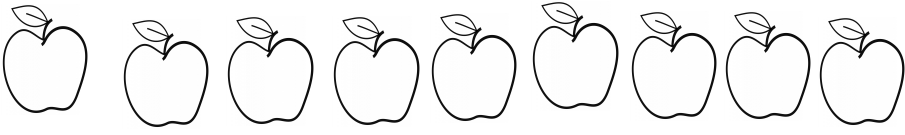
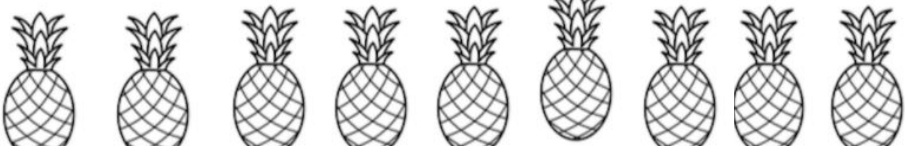
	1
	2
	3
	4
	5
	6
	7
	8

Escola: _____

Nome: _____

Professor: _____

34. LIGUE O NUMERAL AO CONJUNTO CORRESPONDENTE.

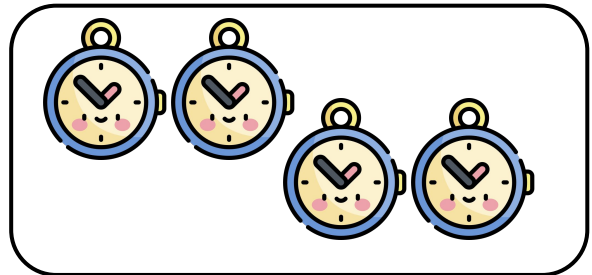
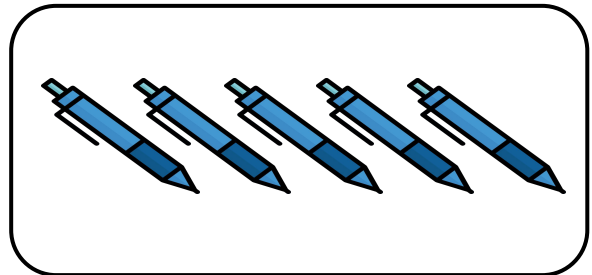
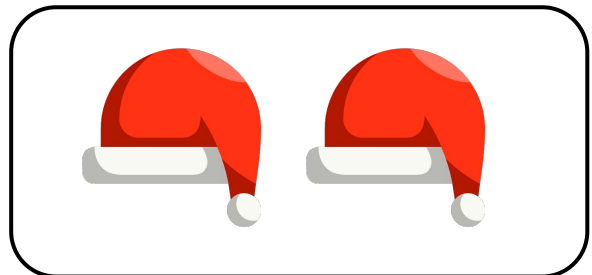
1**2****3****4****5**

Escola: _____

Nome: _____

Professor: _____

COMPLETE AS SEQUÊNCIAS

LIGUE OS NÚMEROS EM ORDEM CRESCENTE E
DESCUBRA O DESENHO QUE ELES ESTÃO FORMANDO E
DEPOIS PINTE O DESENHO FORMADO.

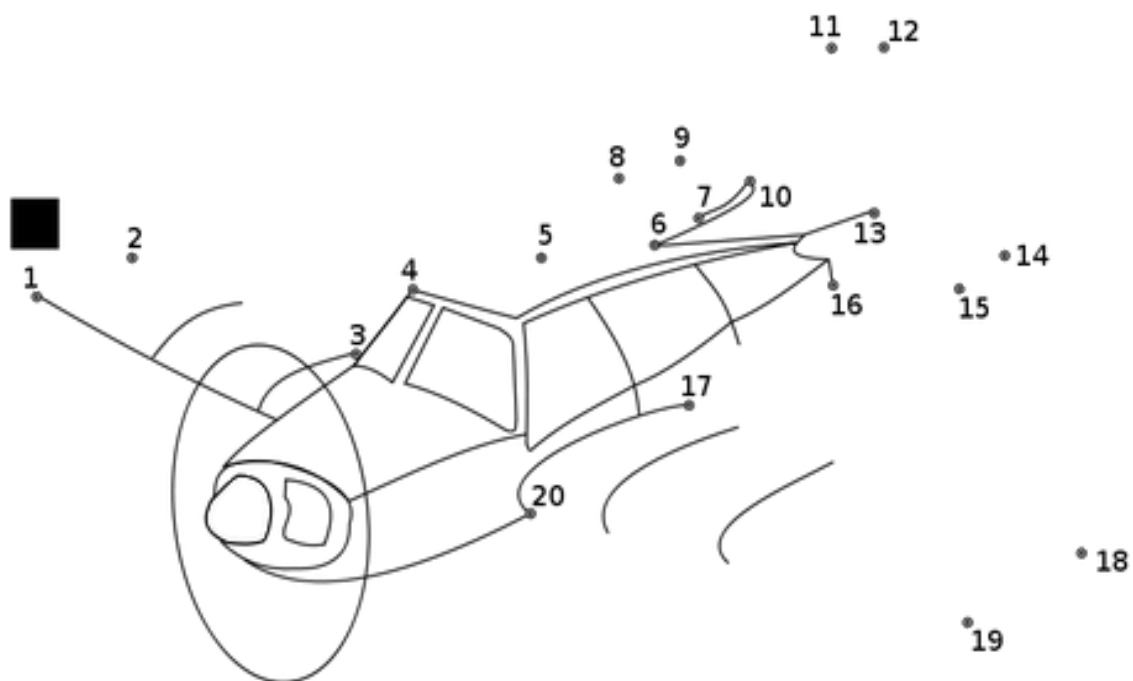

Escola: _____

Nome: _____

Professor: _____

63. CONTE E ESCREVA O NÚMERO DE ELEMENTOS QUE HÁ EM CADA LINHA.

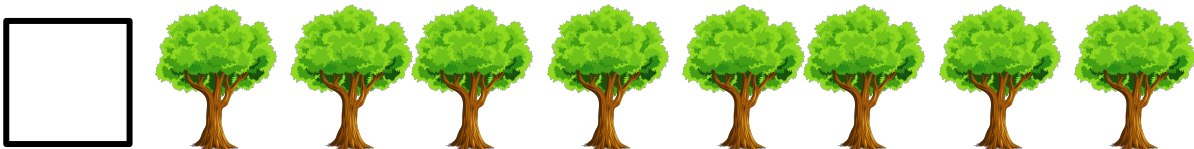
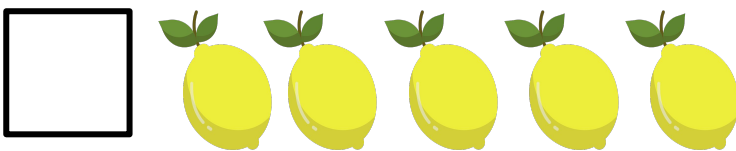
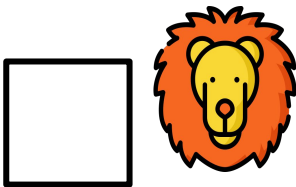







Escola: _____

Nome: _____

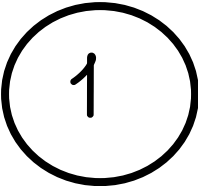
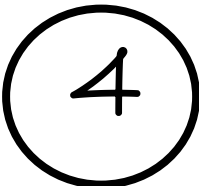
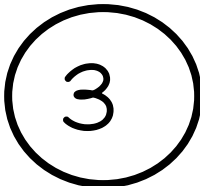
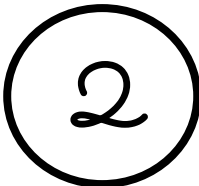
Professor: _____

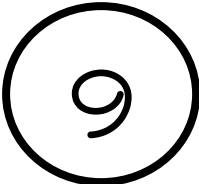
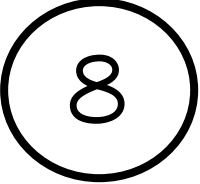
COMPLETE AS SEQUÊNCIAS

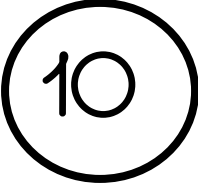
Ajude a menina a organizar os números de 1 a 10 em ordem crescente.

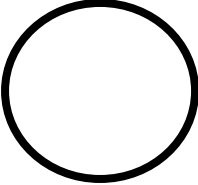
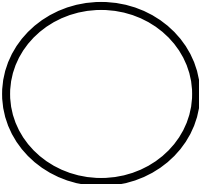
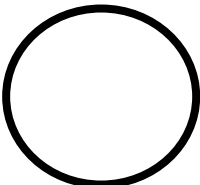
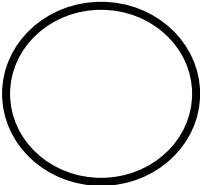
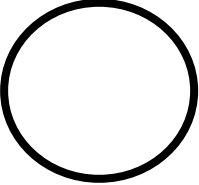
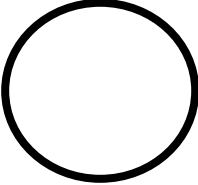
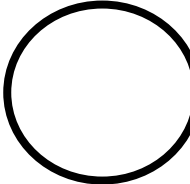
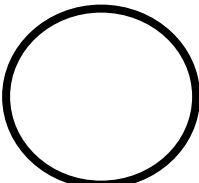
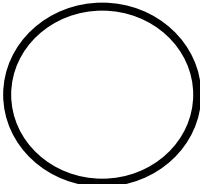

Escola: _____

Nome: _____

Professor: _____

COMPLETE AS SEQUÊNCIAS

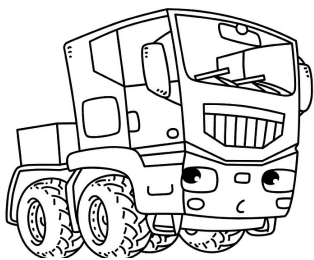

1	2	3	4	5
6	7	8	9	10

Observe os números nos quadrinhos acima e complete a sequência numérica abaixo. Depois complete nos tracinhos.

1		3		5
	7			10

1			4
_____	_____	_____	_____
	6		
_____	_____	_____	_____
	_____	_____	

Escola: _____

Nome: _____

Professor: _____

COMPLETE AS SEQUÊNCIAS



1	2	3	4	5
6	7	8	9	10
11	12	13	14	15

OBSERVE OS NÚMEROS NOS QUADRINHOS ACIMA E COMPLETE A SEQUÊNCIA NUMÉRICA ABAIXO.

1		3		5
	7			10
11		13		

Escola: _____

Nome: _____

Professor: _____

64. REPITA OS NÚMEROS NOS ESPAÇOS.

1 _____

2 _____

3 _____

4 _____

5 _____

Escola: _____

Nome: _____

Professor: _____

64. REPITA OS NÚMEROS NOS ESPAÇOS.

6

7

8

9

10

Escola: _____

Nome: _____

Professor: _____

COMPLETE AS SEQUÊNCIAS



1	2	3	4	5
6	7	8	9	10
11	12	13	14	15
16	17	18	19	20

OBSERVE OS NÚMEROS NOS QUADRINHOS ACIMA E COMPLETE A SEQUÊNCIA NUMÉRICA ABAIXO.

1		3		5
	7		9	
11				15
	17		19	



Cursos **GRATUITOS** para **PROFESSORES, ESTUDANTES E PROFISSIONAIS DA EDUCAÇÃO**

TODOS OS CURSOS COM CERTIFICADOS! UTILIZE PARA:

Horas complementares (faculdade);
Progressão funcional (emprego);
Provas de títulos (Concursos e seleções);
Melhorar o currículo;
E outros.



<https://superpreparadocursos.com.br/>

CURSOS MAIS PROCURADOS

Alfabetização E Letramento Na Educação Infantil - 100 Horas

Práticas em sala de aula na Educação Infantil - 120 Horas

Metodologia de ensino para Professores da Educação Infantil - 140 Horas

Didática da Educação Infantil - 180 Horas

Introdução à Psicopedagogia - 180 Horas

Educação Especial - 110 Horas

Metodologias Ativas da Aprendizagem - 140 Horas

Gestão Escolar e Coordenação Pedagógica - 120 Horas

Conhecendo as 10 Competências da BNCC - 80 Horas

Curso Jogos Matemáticos Na Prática Docente - 120 Horas

Tecnologias Digitais Na Educação - 180 Horas

[ACESSAR TODOS OS CURSOS - CLIQUE AQUI](https://superpreparadocursos.com.br/)

Cursos **GRATUITOS** para **PROFISSIONALIZAR-SE**

Inglês do Zero a Fluência	100h	https://superpreparado.com.br/curso/ingles-do-zero-a-fluencia-2/
Libras	60h	https://superpreparado.com.br/curso/libras/
Técnicas de Redação	30h	https://superpreparado.com.br/curso/tecnicas-de-redacao/
Marketing Digital	40h	https://superpreparado.com.br/curso/marketing-digital-2/
Eletricista residencial	60h	https://superpreparado.com.br/curso/eletricista-residencial/
Auxiliar de Veterinário	80h	https://superpreparado.com.br/curso/auxiliar-de-veterinario/
Atualização em Radiologia	60h	https://superpreparado.com.br/curso/atualizacao-em-radiologia/
Mídias sociais	15h	https://superpreparado.com.br/curso/midias-sociais/
Supervisão Pedagógica	60h	https://superpreparado.com.br/curso/supervisao-pedagogica/
Programação de sites Wordpress	20h	https://superpreparado.com.br/curso/programacao-de-sites-wordpress/
Criação de Loja Virtual	20h	https://superpreparado.com.br/curso/criacao-de-loja-virtual/
Instagram para Vendas	20h	https://superpreparado.com.br/curso/instagram-para-vendas/
Excel Básico e Avançado	60h	https://superpreparado.com.br/curso/excel-basico-e-avancado/
Logística 4.0	60h	https://superpreparado.com.br/curso/logistica-4-0/
Empreendedorismo	40h	https://superpreparado.com.br/curso/empreendedorismo/
Administração	40h	https://superpreparado.com.br/curso/curso-de-administracao/
Gestão em RH	40h	https://superpreparado.com.br/curso/gestao-em-rh/

[ACESSAR TODOS OS CURSOS - CLIQUE AQUI](#)